



The Motion Facilitators

Our specialty graphites for
mechanical engineering

SIGRAFINE®



Graphite Materials & Systems



$\mu = 0$

SIGRAFINE® EK60 Smoother motion

The friction coefficient μ compares the ratio of friction force, required to move two surfaces against one another, to a normal force (e.g. weight), acting on the surface. The lower it is, the better the sliding behavior. Here our SIGRAFINE EK60 graphites boast an exceptional value, significantly lower than that of other materials: $\mu = 0.069$ (for comparison: $\mu = 0.15 - 0.7$ for steel on steel). This delivers decisive advantages in many mechanical applications, such as for rotary vane pumps. Advantages include: reduced energy consumption, environmentally friendly because no lubricants needed, noise reduction ... Our specialty graphites prove they are outstanding motion facilitators.

069



Our specialty graphites for mechanical engineering

Self-lubricating and consistent:
Benefit from the extraordinary material properties and quality of our products for a wide range of mechanical-engineering applications.

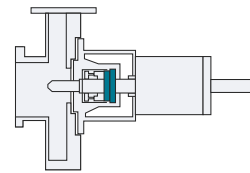
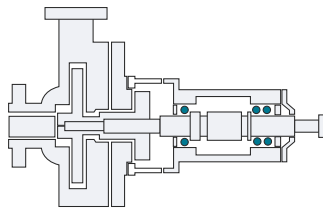

Typical applications

Bearings

- Centrifugal pumps
- Rotary feedthroughs
- Compressors
- Furnace applications
- Process pumps

Seal rings

- Mechanical seals
- Centrifugal pumps
- Rotary feedthroughs
- Compressors
- Water turbines
- Ventilators and propeller shafts

Products of SGL Carbon

- Cylindrical bearings
- Flanged bearings
- Axial bearings

- Seal rings
- Segmented packings
- Labyrinth seals
- Piston and guide rings
- Ball valve seals, metal sleeved rings
- Steam joints
- Motion control rings and segments

Materials used by SGL Carbon

- SIGRAFINE® die-molded, isostatic carbon and graphite

- SIGRAFINE® die-molded, isostatic carbon and graphite
-

Your benefits

Excellent dry-running properties, high energy efficiency thanks to minimum friction, extremely temperature and corrosion resistant, outstanding mechanical material strength.

Even for very different areas in vacuum technology – from medical applications to food technology – we offer a wide range of products and semi-finished goods.

Take advantage of our application-technical expertise. We are glad to advise you on how to optimize your processes, and will work with you to find specific solutions to your needs.

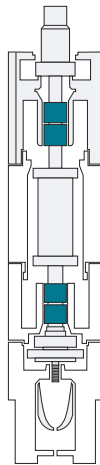
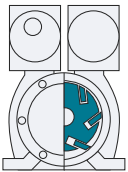

Vanes and rotors

- Process pumps
- Vacuum pumps
- Compressors
- Radial blowers

- Vanes
- Rotors
- End plates
- Housings

- SIGRAFINE® die-molded, isostatic carbon and graphite
- Synthetic resin-bonded graphite

Semi-finished products and powders

- For all mechanical applications
- Filler for plastic compounds

- Semi-finished products
- Powders

- SIGRAFINE® die-molded, isostatic carbon and graphite
- Synthetic resin-bonded graphite
- Carbon and graphite powder

Other applications

- Machine elements and controls
- Medical applications
- Motors
- Valve seats

- Control cams
- Pistons
- Sliding elements
- Electrodes
- Many more products

- SIGRAFINE® die-molded, isostatic carbon and graphite
- Synthetic resin-bonded graphite

Applications for mechanical engineering

Their self-lubricating property and extreme consistency make our SIGRAFINE graphite products ideal components in a wide range of applications. These range from rotors and vanes for compressors, commutators, and sliding bearings and seals for fuel pumps to sliding bearings for kitchen ovens.



SIGRAFINE rod bearing and pump

SIGRAFINE® specialty graphites for dry-running compressors and vacuum pumps

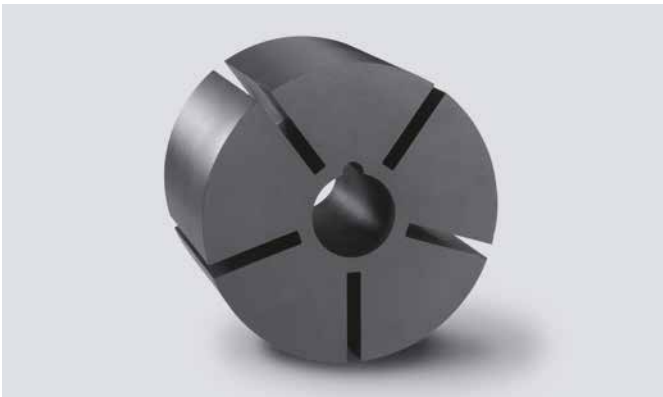

↑ Rotor for vacuum pumps, manufactured with PTS technology (see page 11).



Environmentally-friendly vacuum technology

When it comes to environmentally-friendly processes, vacuum technology enables oil-free pumping in sensitive environments. It is commonly used in many production processes of different industries, such as the chemical and pharmaceutical, print and paper industries, food packaging, coatings, and pick-and-place applications.

We manufacture rotors and vanes made of pitch- and resin-bonded carbon materials for compressors and vacuum pumps.

Consistency, service life, efficiency

Thanks to their material properties, our SIGRAFINE materials boost the energy efficiency of processes. Moreover, their high chemical resistance and long service life contribute to safety and economic efficiency.

Overview of applications

We manufacture the following products for dry-running compressors and vacuum pumps:

- End plates
- Seal rings
- Vanes
- Rotors
- Casings
- Semi-finished products

We provide a range of materials and impregnations for various demands.

SIGRAFINE® specialty graphites for pump applications and slide-ring seals



↑ Carbon-graphite seal ring for process pumps.

Reduced wear – less maintenance effort

Graphite and carbon-graphite slide-ring seals are, by far, the most common system for compression-loaded shaft seals. They have replaced conventional gland packing technology and boast low leakage, friction, and wear, and correspondingly low maintenance.

Widespread use – high safety

Slide-ring seals enjoy a wide range of application, spanning from pumps and centrifuges to agitators and mixers. The high material quality of our seal rings enhance the process and product safety of your applications.

Thanks to our comprehensive knowledge of applications, we are able to provide you with in-depth advice in selecting the right material.

Overview of applications

We make seal rings (D), bearings (L) and vanes (T) for the following applications:

- Process pumps (D, L)
- Fuel pumps (L, T)
- Circulation pumps (D, L)
- Submersible pumps (D, L)
- Slide-ring seals (D)
- Specialty seals (D)
- Rotary feedthroughs (D, L)

We supply a range of materials and impregnations for various demands.

SIGRAFINE® specialty graphites for other applications



↑ Steam-admission head ring for a rotary feedthrough.



↑ Spherical bearings for applications up to 400 °C.

Wide range of use, including for special conditions

Our products also provide ideal solutions for many more branches of industry, encompassing such diverse areas of application as textile machines, kitchen ovens and conveyor belts. Especially for demanding requirements involving temperature resistance or purity, for instance, SIGRAFINE graphites have the right properties.

Self-lubrication advantage

Specifically in medical, food-technology and water-supply applications where contamination, such as from lubricants, must be prevented at all costs, the self-lubricating property of graphites delivers a crucial advantage. This is true for both high-temperature applications and for low-lubricating, corrosive media.

We support you

We offer a wide variety of types and impregnations with different properties, and are happy to provide you with support in selecting materials suited to your specific requirements. Just ask us!

Overview of typical applications of SIGRAFINE® specialty graphites

	Products	Advantages over other materials
Blowers	Rotors/vanes	geometry, weight, wear-resistance, self-lubrication, low noise operation
Conveyor belt chains	Sliding bearings	temperature-resistance, wear-resistant, self-lubricating
Conveying elements	Sliding elements	very low wear
Cooking ovens	Sliding bearings	non hazardous, temperature-resistance
Aquarium pumps	Sliding bearings	non hazardous, self-lubricating, corrosion-free
Flow meters	Sliding bearings	non hazardous, self-lubricating, corrosion-free
Cigarette production	Control rings and segments	low abrasion, non hazardous
Textile machines	Sliding elements and sliding bearings	very low wear, temperature-resistance at high rotation, wear-resistance, high strain
Machine elements	Sliding bearings and special designs	self-lubricating, temperature-resistance, dimensionally stable, corrosion-free (inert)
Medical applications	Sliding bearings	low wear rates, temperature-resistance at high rotations, wear-resistance, high strain, low noise operation, non hazardous, corrosion-free against most cleaning agents
Motors/actuators	Sliding bearings	temperature-resistance, long service life, high strain resistance, small assembly dimensions, self-lubricating, low noise

SIGRAFINE® materials and their properties

Outstanding mechanical, thermal and chemical properties - foremost its self-lubricating behavior - make our specialty graphite the go-to choice for a multitude of mechanical-engineering applications.

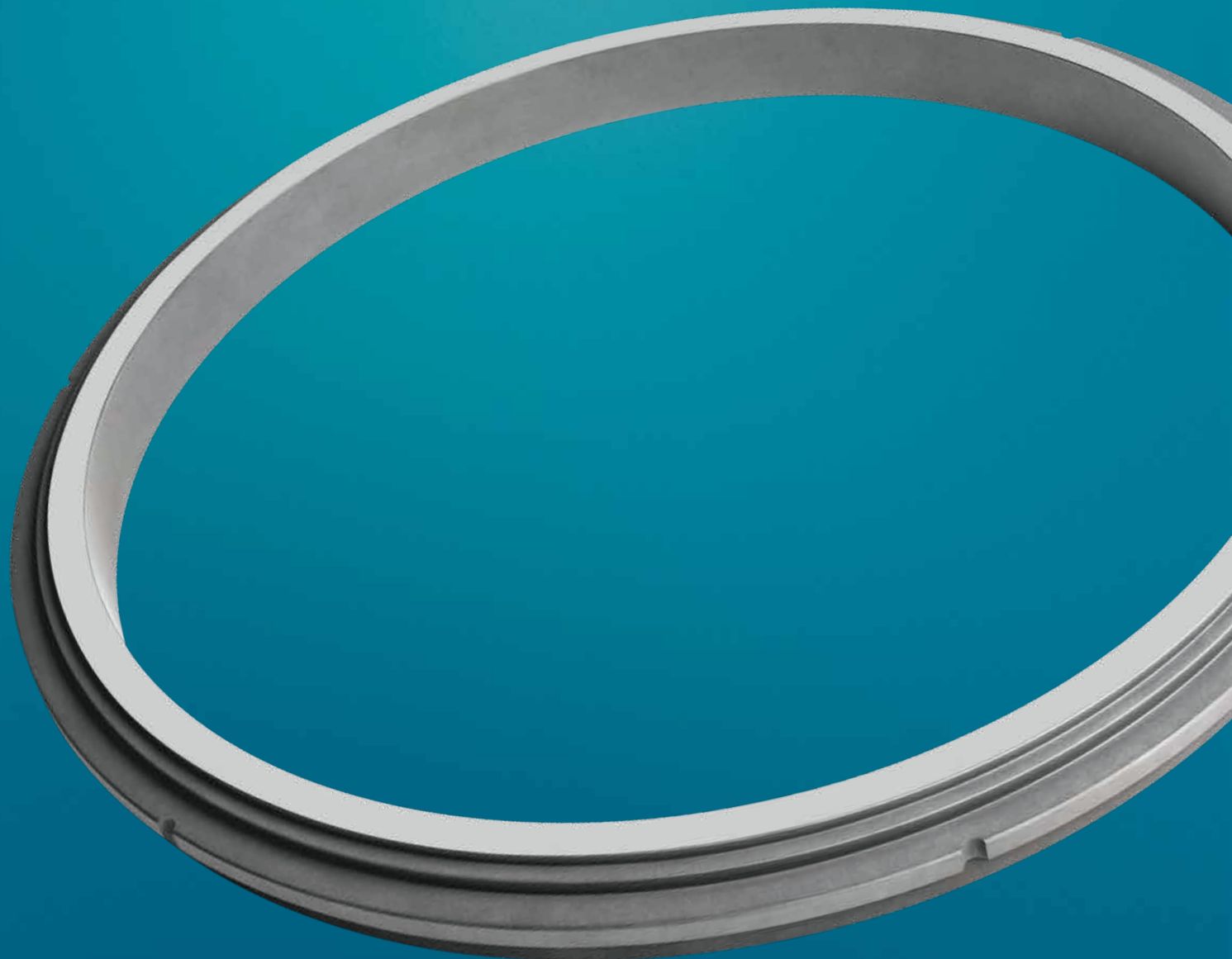

A manufacturing process that generates quality

The outstanding properties of our SIGRAFINE graphite and carbons – gliding ability, electrical conductivity, corrosion and thermal resistance, among others – can be attributed to the depicted production process. Seven phases, from high quality raw material to product, ensure consistent composition of the crystalline graphite structure; targeted changes to the process steps and the formula make it possible to influence the behavior of the material according to need.

Increased cost-effectiveness: PTS technology

We can implement pressed-to-size technology (PTS) in many areas: Near-net-shape pressings make it possible to manufacture complex component parts in large numbers at low materials usage. Since mechanical end machining is entirely or largely unnecessary, this process is especially cost-efficient.

Impregnation for optimized properties

Metal, phosphate, and synthetic resin impregnations improve physical properties and reduce wear. We impregnate our SIGRAFINE special graphite with synthetic resins, salts and saline solutions, as well as with metals such as antimony and metal alloys such as bronze.

All carbon – the ultrapure alternative

For applications in which no foreign substance can come into play due to health and environmental considerations, or for technical reasons, our product lineup includes a variety of coked carbon featuring specific advantages: They are free of metals, have enhanced chemical resistance, and are distinguished by higher temperature resistance than materials impregnated with synthetic resin.

Here the self-lubricating property of graphite especially comes into effect, since contamination from lubricants can be ruled out from the start.

Manufacturing process

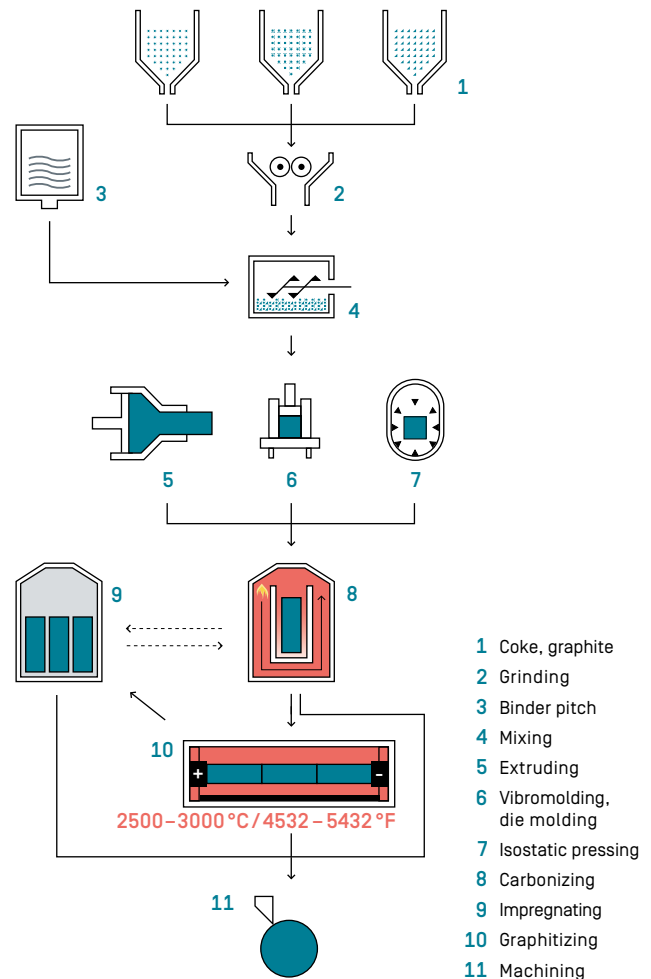

Material data for our SIGRAFINE® fine-grain graphites

Typical properties	Units	Die-molded carbon and graphite					Isostatic graphite
		EK20	EK23	EK24	EK40	EK60	V1626
Density	g/cm ³	1.70	1.75	1.70	1.70	1.73	1.85
Hardness	Rockwell B HR _{5/100}	105	105	105	95	80	90
Flexural strength	MPa	55	40	60	35	80	58
Compressive strength	MPa	155	100	180	100	120	150
Young's modulus	GPa	22	14	18	10	22	13
Thermal expansion [20–200 °C/68–392 °F]	10 ⁻⁶ K ⁻¹	3.0	5.0	4.1	4.5	11.0 ¹⁾	4.0
Thermal conductivity	Wm ⁻¹ K ⁻¹	12	13	14	25	6	73
Thermal resistance in oxidizing atmosphere	°C	350	350	350	500	180 ²⁾	600
	°F	662	662	662	932	356	1112

¹⁾ from 20 °C [68 °F] to 150 °C [302 °F] ²⁾ Brief maximum application temperature. Physical values can change with lasting temperature load.

Low wear and long-term stability

Our die-pressed carbons and graphites boast low material wear and thereby long service life. We offer a variety of types to allow us to respond to different frame conditions.

Application competency and materials consulting

Many factors influence wear behavior: material pairing, sliding speed, strain, surface finish of bearing surfaces, particle contamination and operating conditions. We take a holistic view of the tribological system, and find the material solution best suited to your specific requirements.

Thermal conductivity – a key property

SIGRAFINE materials also boast excellent thermal conductivity, which is usually more pronounced in graphite than in the surrounding components, thereby preventing overheating and excessive abrasion, and extending the service life of the system.

If, on the other hand, little heat is to be diverted, the low conductivity of carbon-graphite provides good insulating properties.

Variety with low wear rates

Wear behavior of some SIGRAFINE material types in wet running

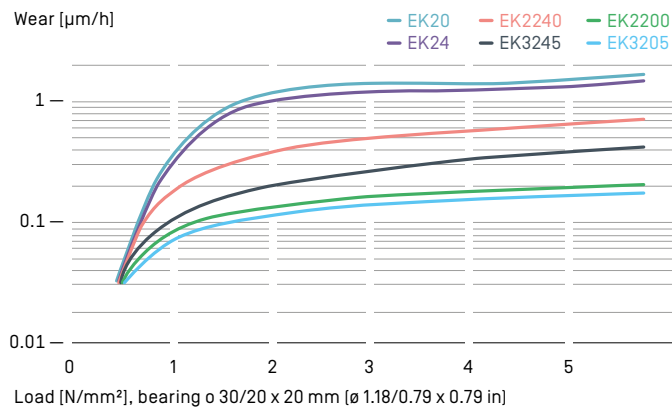

Wear behavior of some SIGRAFINE material types in dry-running

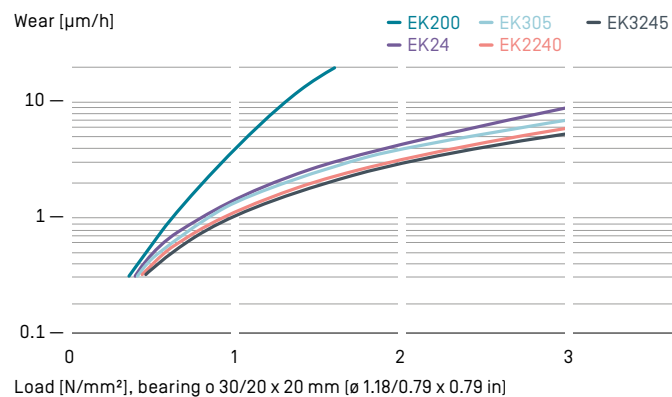

Variety in friction

Coefficient of friction depending on temperature in SiC discs (Ra=0.2)

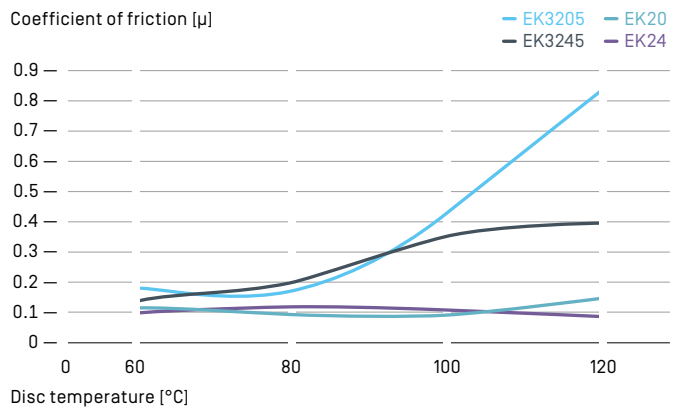

Coefficient of friction depending on temperature in gray cast iron 20 (Ra=0,3)

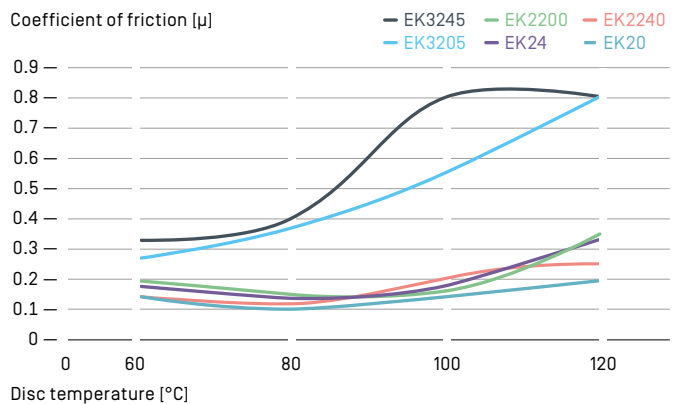

The coefficients of friction were determined in a pin-on-disc test at 11 m/s (36.1 ft/s), a relative relative air humidity between 36 % and 43 % and a heated disc.



↑ Radial bearing of carbon-graphite, made with PTS technology, for submersible pump motors.

Safety from temperature and thermal-shock resistance

Of all known materials, graphite has the highest temperature-change resistance. Thanks to their high purity, SIGRAFINE materials of graphite and carbon-graphite contribute significantly to process reliability.

Adjustable expansion behavior

Good physical compatibility of the materials employed is also relevant. To achieve this they must display the same or similar thermal expansion coefficients. By targeted selection of formula components, we can set the coefficient of expansion of our SIGRAFINE specialty graphite to the values of the relevant partner material.

The clear leaders in temperature-change resistance

Thermal shock resistance of various materials

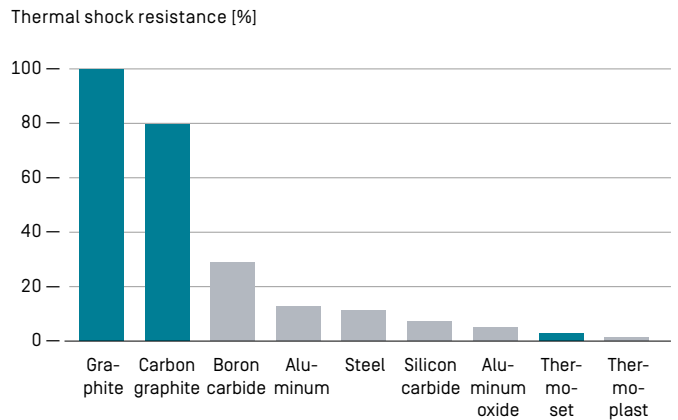

Clearly defined thermal-conductivity behavior

Thermal conductivity of different materials

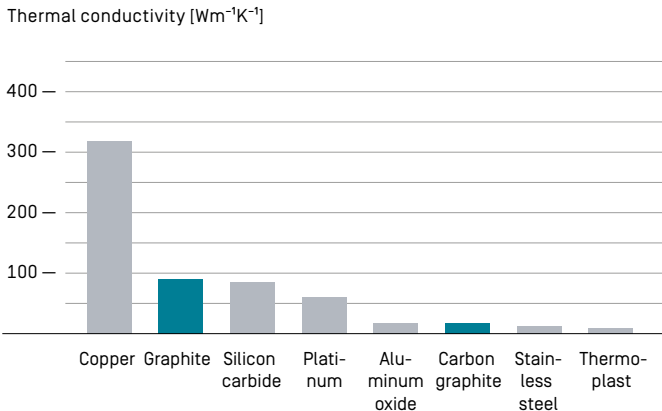

Low expansion in heat

Coefficient of thermal expansion of various materials

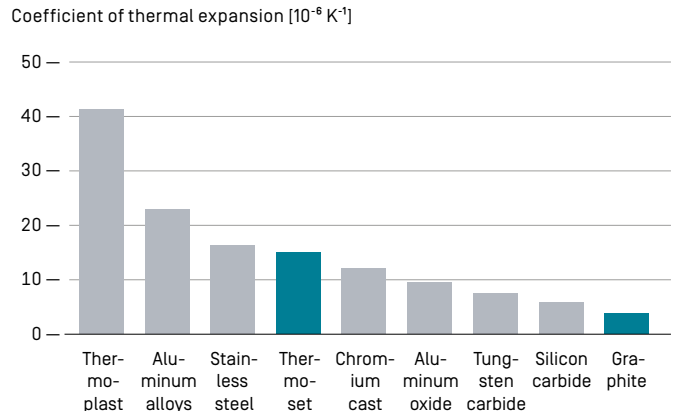

Counterface materials and design recommendations

Optimum system performance is achieved by selecting the suited SIGRAFINE type and impregnation, and by the appropriate design.



Counterface materials

For wet- and dry-running

Our SIGRAFINE materials are suitable to both wet- and dry-running, as well as to mixed friction applications. In dry-running conditions, surface finish should be of a higher standard than when wet-running, because the liquid film has a compensatory and friction-reducing effect, even in hydrodynamically poor media such as water or gasoline.

Individually adjustable for maximum performance

The selection of material type and impregnation depends on the counterface material. This minimizes wear and boosts cost-efficiency. The thermal expansion coefficient, for instance, can be precisely controlled in order to optimally align SIGRAFINE to the counterface.

We advise you

You can rely on our comprehensive know-how. By providing application-specific materials consulting in advance, we help you achieve a perfect counterface fit, thereby significantly enhancing system performance.



↑ Bearing and sliding elements of carbon-graphite.

Recommended surface finish of metallic counterface

	$v < 0.5 \text{ m/s}$ $p < 0.1 \text{ N/mm}^2$	$v < 1 \text{ m/s}$ $p < 0.2 \text{ N/mm}^2$	$v < 3 \text{ m/s}$ $p < 0.3 \text{ N/mm}^2$
Rz μm	≈ 1	0.5 ... 0.8	< 0.5

Recommended counterface

SIGRAFINE is especially suitable as a counterface for hard materials such as:

- Gray cast-iron
- Steel [hard], alloyed and unalloyed, as well as nitrided
- Hard metal
- Aluminum oxide
- Silicone carbide
- Glass
- DLC¹⁾-coated materials

SIGRAFINE has limited suitability, for instance, for soft steel [alloyed and unalloyed], light-metal alloys, chromed materials, non-ferrous metal and carbon materials.

¹⁾ DLC = Diamond-Like-Carbon

Wear behavior depending on counterfaces

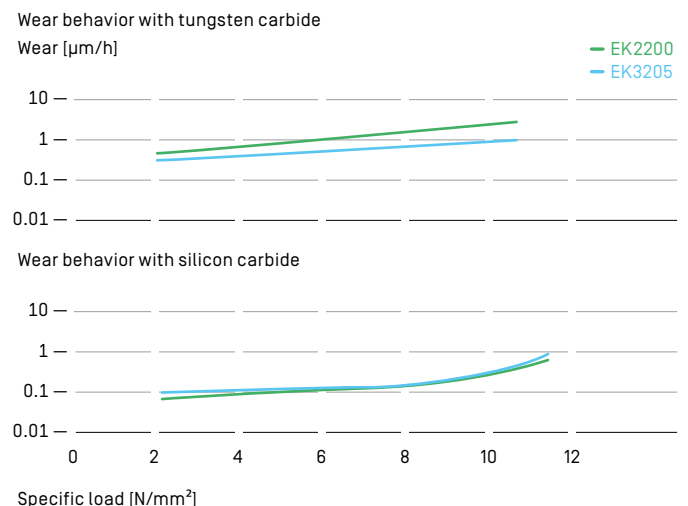

Wear behavior for counterfaces made of materials, a constant sliding speed of 9 m/s (29.5 ft/s) and increasing load. Medium: demineralized water.

Proven constructions for greater safety

The following recommendations for design and evaluation are based on longstanding project and application experience. Our design recommendations have proven themselves over the years and help achieve maximum process reliability by minimizing such risks as broken bearings.

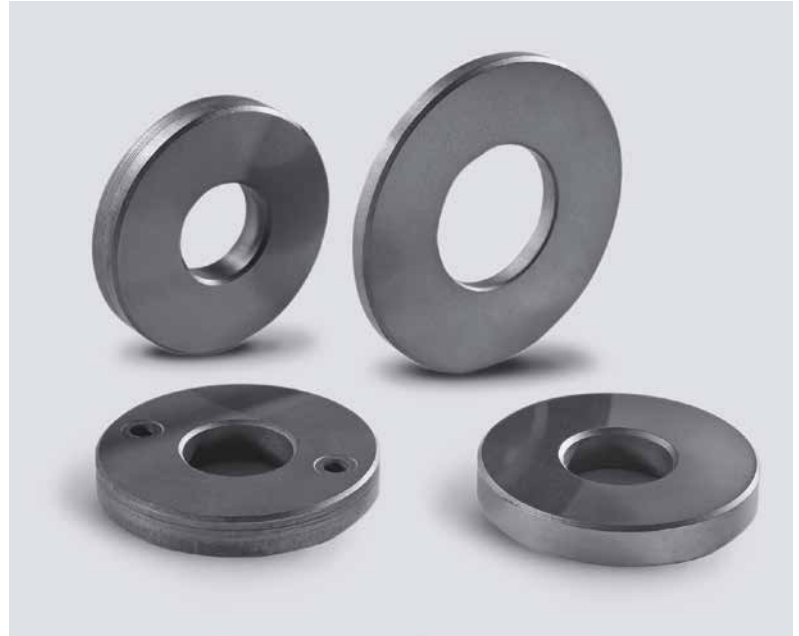

↑ Axial bearing of carbon-graphite for submersible motor pumps.

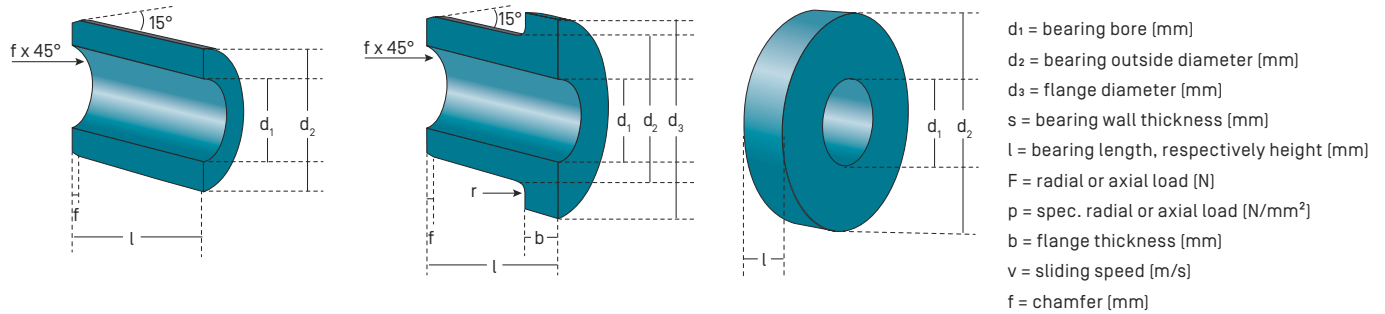

Fitting

Method of fitting	Recommended ISO tolerances		Max. Operating Temperature °C	
	d_1	d_2 Housing diameter		
Cold press fitting	before F7 after H7 ... H8	s6	H7	about 150 ¹⁾
Shrink fitting	before D8 after E8 ... E9 ²⁾	x8 ... z8	H7	about 300 ³⁾

¹⁾ For housing materials having a thermal expansion of $\alpha > 12 \times 10^{-6}/K$ the maximum operating temperature is correspondingly reduced.

Press fitting is conducted with a stepped fitting pin with a tolerance of h5.

²⁾ We recommend that the bearing bore be finished to size after shrink fitting.

³⁾ For higher temperatures and for housing materials having a thermal expansion of $\alpha > 12 \times 10^{-6}/K$ the special tolerances and/or a locking arrangement may be employed – please inquire about this.

Calculation guidelines and supplementary information

Cylindrical and flanged bearings – design guidelines and calculation

Dry running and mixed running		
Bearing dimensions	$v \text{ (m/s)} \leq 1$	projected bearing area $l \times d_1 \geq \frac{F}{0.3 \text{ (N/mm}^2\text{)}}$ $l \leq 2 d_1$
	$v \text{ (m/s)} \leq 0.1$	projected bearing area $l \times d_1 \geq \frac{F}{1.5 \text{ (N/mm}^2\text{)}}$ $l \leq 2 d_1$
Bearing clearance	0.3 ... 0.5 %	of shaft diameter at operating temperature (warm clearance)
	0.3 ... 0.5 %	of shaft diameter at operating temperature (cold clearance) if shrunk into a metal housing
Coefficient of friction	0.10 ... 0.15	for mixed running
	0.15 ... 0.25	for dry running
Wet running		
Bearing dimensions ¹⁾	$v \text{ (m/s)} \leq 20$	projected bearing area $l \times d_1 \geq \frac{F}{0.3 \text{ (N/mm}^2\text{)}}$ $l \leq 2 d_1$
	$v \text{ (m/s)} \leq 15$	projected bearing area $l \times d_1 \geq \frac{F}{0.5 \text{ (N/mm}^2\text{)}}$ $l \leq 2 d_1$
Bearing clearance ¹⁾	0.1 ... 0.3 %	of shaft diameter at operating temperature (warm clearance)
	0.1 ... 0.3 %	of shaft diameter at operating temperature (cold clearance) if shrunk into a metal housing
Coefficient of friction	0.01 ... 0.05	
¹⁾ Observe the laws of hydrodynamics.		
Information for wet and dry running		
Tolerances	Outside diameter	IT 6/IT 7
	Bore	IT 7/IT 8
Surface finish	Outside diameter	Ra = 6.3 µm ... 3.2 µm
	Bore	Ra = 3.2 µm ... 0.8 µm
Bearing design	Do not subject bearing to tension, shear or bending stress	
Fitting	Cold fitting, shrink fitting, bonding	
Counterface materials (surface finish)	Generally hard materials, e. g. HRC > 50, Rz = 0.5 ... 0.8 µm	

Axial bearings – calculation guidelines and supplementary information

	Dry Running/Mixed Running	Wet Running
Bearing area A (mm ²)	$v \text{ (m/s)} \leq 1$ $A \geq \frac{F}{0.3 \text{ (N/mm}^2\text{)}}$	$v \text{ (m/s)} \leq 20$ $A \geq \frac{F}{1.0 \text{ (N/mm}^2\text{)}}$
Coefficient of friction	0.1 ... 0.25	0.01 ... 0.05
Surface finish	Bearing surfaces fine-ground to lapped	Bearing surface lapped
Bearing design	Solid or split	Solid or split, lubricating grooves
Fitting	Cold press fitting, shrink fitting, screws, nuts and form closure	
Counterface materials (surface finish)	Generally hard materials, e. g. HRC > 50; Rz = 0.5 ... 0.8 µm	

Examples of application

Example: Axial bearing calculation

Wet running

Bearing dimensions

Bearing bore $d_1 = 20$ mm (given)

Bearing outside $\varnothing d_2$ By going back and calculating from the required area

$$A = \frac{F}{1.0} = \frac{500}{1.0} = 500 \text{ mm}^2$$

$$A = \frac{\pi (d_2^2 - d_1^2)}{4}$$

this results in

$$d_2 = \sqrt{\frac{A \times 4}{\pi} + d_1^2}$$

$$d_2 = \sqrt{\frac{500 \times 4}{\pi} + 20^2}$$

$$d_2 = 32 \text{ mm}$$

Bearing outside \varnothing

chosen as $d_2 = 35$ mm

Bearing height $l > 0.1 d_2$

chosen as $l = 5$ mm

Given values: Shaft \varnothing 20 mm; Sliding speed $v = 3$ m/s; Load $F = 500$ N; Medium Water; Temperature 30°C

Example: Cylindrical bearing calculation

Dry running

Bearing dimensions

Projected bearing area $l \times d_1 > \frac{F}{0.3} = \frac{150}{0.3} = 500 \text{ mm}^2$

Bearing bore $d_1 > \frac{l}{2}$

chosen as $d_1 = l$
 $d_1 = \sqrt{500} = 22.36$ mm

rounded up $d_1 = 23$ mm

Bearing length $l = \frac{500}{23} = 21.7$ mm

rounded up $l = 22$ mm

Bearing outside \varnothing $d_2 = d_1 + 2s$
 $s_{\min} = 0.15 \times d_1 = 3.45$ mm
 $23 + 2 \times 3.45 = 29.9$ mm

rounded up $d_2 = 30$ mm

Bearing dimensions $\varnothing 30/23 \times 22$ mm

Bearing play

Dry running 0.3 ... 0.5% of shaft $\varnothing d$

Shaft $\varnothing 20$ mm $d = 23$ h6

Bearing clearance (min.) $0.3\% \times 23 = 0.069$ mm
{added to nominal bore}

Bearing tolerances

Bearing outside \varnothing chosen s6 [cold press fitting]

Bearing bore chosen F7

This results in: $\varnothing 30$ s6 / 23.069 F7 $\times 22$ mm

Given values: Sliding speed $v = 0.5$ m/s; Load $F = 150$ N; Temperature 60°C



↑ Cylindrical bearing made of die-molded carbon.

Design recommendations

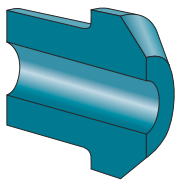

Avoid sharp steps in the bore and on the outside. Break sharp edges!

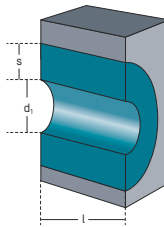

Cylinder thickness
 $l \leq 2d_1$
 $s = 0,15 \dots 0,2 \times d_1$;
 $s_{min} = 3 \text{ mm}$

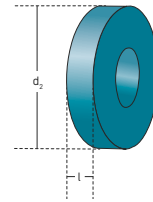

Height
 $l \geq 0,1 d_2$; not under 3 mm, if possible

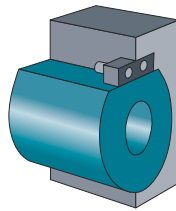
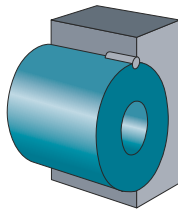
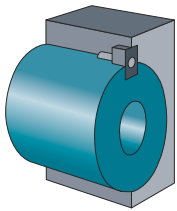

Any arrangement such as a check plate or plain pin to **prevent rotation** should be provided in an unloaded area, not in the bore. Any keyway should be axial and milled out carefully to avoid breakage.

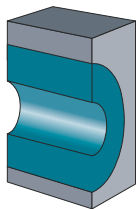

Cylindrical bearings should not be fitted to be self-supporting. They should be fully supported by the housing or by a special metal bushing

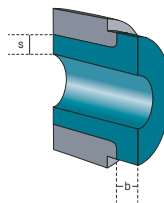

Flange thickness should be at least equal to wall thickness. A transitional angle should be radiused; machine the housing thrust face for the flange. $b \geq s$



↑ Various bearings made of die-molded carbon.

Successful together

We do not just manufacture products, but also provide intelligent solutions with sustainable benefits for our customers.

Close collaboration and an understanding of specific requirements allow us to develop forward-looking solutions and respond to specific needs.

This has given rise to most of our innovation – such as our resin bonded graphite.





A formula against wear

The service life of parts is a crucial factor in the cost-effectiveness of dry-running vane compressors and vacuum pumps. Our SIGRAFINE vanes, rotors, end plates and casings deliver outstanding performance based on the self-lubricating quality of graphite and its stability.

A specific application condition of one of our customers required a material featuring especially low wear, while at the same time especially high stability. In a close working relationship and by tweaking the formula, we developed a new type of our resin-bound SIGRAFINE specialty graphite with a significantly lower coefficient of friction and higher stability in the process.

The new material significantly reduces the wear rate of vanes in dry-running compressors and vacuum pumps. This considerably lengthens the service life of the devices – a crucial success factor.

Smart Solutions

Be it materials, components or production processes, we focus our thinking and actions on the customer and keep an eye on the big picture. Our solutions already anticipate the future today.

The following examples show a selection of our unique product range.

Mobility

- Lightweight components and structural parts based on fiber-reinforced composites for automotive and aerospace manufacture
- Graphite anode material for lithium-ion batteries in electric vehicles
- Carbon-ceramic brake disks for sports cars and luxury sedans

Energy

- High-temperature solutions based on specialty graphites and fiber materials for the photovoltaic industry
- Carbon fiber materials for rotor blades
- Gas diffusion layers for fuel cells
- Systems for more efficient heat exchange and heat recovery
- Carbon fibers for pressurized gas containers

Digitization

- Carbon, graphite, and CFC components for polysilicon and monocrystal pulling in the semiconductor industry
- High precision, coated graphite carriers for the production of LEDs

→ State-of-the-art green production with the world's largest isostatic press



SGL Carbon

We are leaders in the development and manufacture of products based on carbon, graphite, carbon fibers, and fiber-reinforced composites. In partnership with our customers, we develop intelligent, trendsetting, and sustainable solutions that deliver a clear benefit.

With our in-depth material, engineering, and application know-how, we make a substantial contribution to the major future topics mobility, energy, and digitization.



Contact

Europe / Middle East / Africa

SGL CARBON GmbH
Drachenburgstrasse 1
53170 Bonn/Germany
mechanical-europe@sglcarbon.com

Americas

SGL CARBON LLC
900 Theresia Street
PE 15857 St. Marys/USA
mechanical-america@sglcarbon.com

Asia / Pacific

SGL CARBON Far East Ltd.
151 Huan Chen Dong Lu
Shanghai Fengpu Industrial Development Zone
201401 Fengxian/China
mechanical-asia@sglcarbon.com

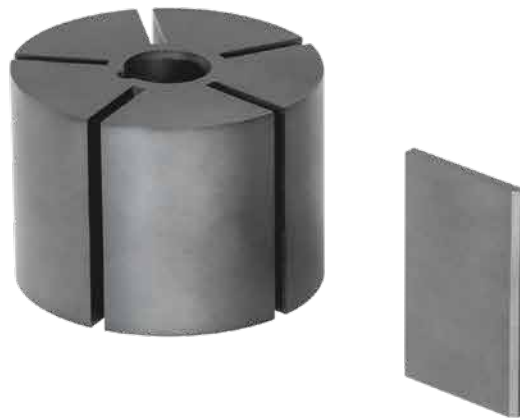

® registered trademarks of SGL Carbon SE

This information is based on our present state of knowledge and is intended to provide general notes on our products and their uses. It should therefore not be construed as guaranteeing specific properties of the products described or their suitability for a particular application. Any existing industrial property rights must be observed. The quality of our products is guaranteed under our "General Conditions of Sale".

05 2018/1 E Printed in Germany



Graphite Materials & Systems
SGL CARBON GmbH
Soehnleinstrasse 8
65201 Wiesbaden/Germany
www.sglcarbon.com/gms